

47<sup>th</sup>  
Annual  
**FISH DERBY**

# Grand Lake Sportsmen's Club

*Saturday, July 8, 2023*



*Est. 1965*

[www.grandlakesportsmen.org](http://www.grandlakesportsmen.org)

## 47<sup>TH</sup> ANNUAL FISH DERBY

### • Fish Derby at Grand Lake •

SPONSORS FOR EACH FISH CATEGORY (see inside brochure)

Northern Pike, Walleye, Bass, Perch, and Rock Bass

1<sup>st</sup> Place...\$80.00

2<sup>nd</sup> Place...\$70.00

3<sup>rd</sup> Place...\$60.00

4<sup>th</sup> Place...\$50.00

5<sup>th</sup> Place...\$40.00

6<sup>th</sup> Place...\$30.00

7<sup>th</sup> Place...\$20.00

### SPECIAL KIDS DIVISION – 12 & UNDER

Bluegill, Perch, Bass and Rock Bass (see inside)

One prize per person, per category

Largest fish will be decided by length only.

••• NO ENTRY FEE •••

### FISH DERBY AWARDS

Check-in from 10 a.m. - Noon and 5-8 p.m. at Pavilion

FLETCHER GILCHRIST PARK

(North End Park)

14300 Highway 638 East, Presque Isle, MI 49777

**PLEASE SUPPORT THE SPONSORS IN THIS BOOKLET**



Doug Nitchman,  
Owner/Operator

- Directional Boring
- Trenching
- Plowing
- Aerial Construction

Cell: (231) 657-8966

Office/Fax: (231) 487-0583

E-mail: [nuc@charter.net](mailto:nuc@charter.net)

### ***Sponsor of the Perch Division***

1<sup>st</sup> Place...\$80.00

2<sup>nd</sup> Place...\$70.00

3<sup>rd</sup> Place...\$60.00

4<sup>th</sup> Place...\$50.00

5<sup>th</sup> Place...\$40.00

6<sup>th</sup> Place...\$30.00

7<sup>th</sup> Place...\$20.00

*Ties decided by time measured.*





**New Owners: Greg & Aleisha Roznowski**

**Metz, MI**

**989-766-2380**

**Homemade Burgers, Deep Fried Food, Smoked Food**

*“Good Place For Cold Beer & Good Food!”*

**Sponsor of the Pike Division**

1st Place.....\$80	4th Place.....\$50
2nd Place.....\$70	5th Place.....\$40
3rd Place.....\$60	6th Place.....\$30
	7th Place.....\$20



# **BAYSIDE BAIT**

11570 Bell Bay Rd.,  
Presque Isle, MI 49777

**(989) 595-2989**

Wholesale Retail

*Lynn Morrison, Owner*

## ***Sponsor of the Walleye Division***

1<sup>st</sup> Place...\$80.00  
2<sup>nd</sup> Place...\$70.00  
3<sup>rd</sup> Place...\$60.00

4<sup>th</sup> Place...\$50.00  
5<sup>th</sup> Place...\$40.00  
6<sup>th</sup> Place...\$30.00  
7<sup>th</sup> Place...\$20.00

*Ties decided by time measured.*

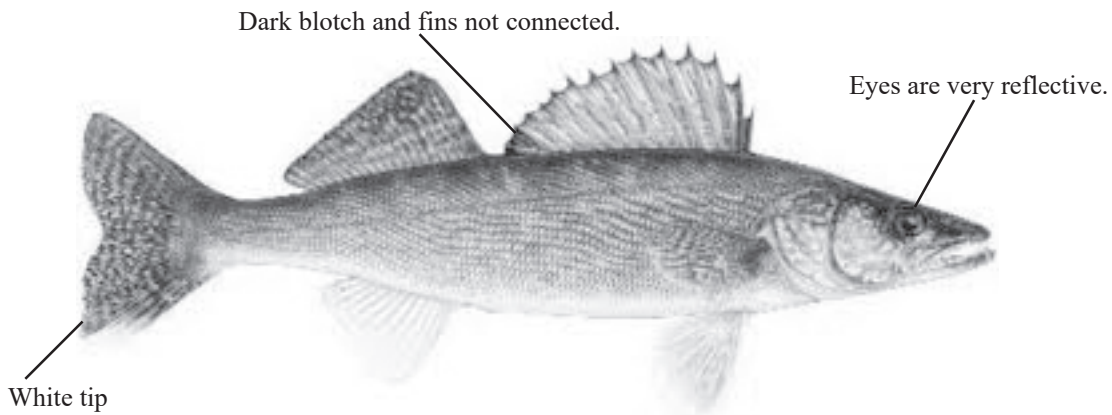

# *Al Bourdeau* INSURANCE AGENCY

Serving Michigan For Over 100 Years



Purchasing high-quality insurance can be quick and easy, and it doesn't have to be expensive. You just need to find the right insurance agency:

**Al Bourdeau Insurance Agency**

Home - Auto - Boat - Business  
**DaveB@albourdeau.com**

## 800-644-6030

[www.albourdeau.com](http://www.albourdeau.com)

### ***Sponsor of the Bass Division***

1<sup>st</sup> Place...\$80.00  
2<sup>nd</sup> Place...\$70.00  
3<sup>rd</sup> Place...\$60.00



4<sup>th</sup> Place...\$50.00  
5<sup>th</sup> Place...\$40.00  
6<sup>th</sup> Place...\$30.00  
7<sup>th</sup> Place...\$20.00

*Ties decided by time measured.*

*Certified*  
Piedmontese  
Wagyu Beef

1313 Erskine  
Detroit, MI  
48207

# Fairway Packing Co.

Prime Beef

Dry Aged Beef

**JOE BARATTA**

(313) 832-2710 • Fax: (313) 832-1649

[www.fairwaypacking.com](http://www.fairwaypacking.com)

## *Sponsor of the Rock Bass Division*

1<sup>st</sup> Place...\$80.00

4<sup>th</sup> Place...\$50.00

2<sup>nd</sup> Place...\$70.00

5<sup>th</sup> Place...\$40.00

3<sup>rd</sup> Place...\$60.00

6<sup>th</sup> Place...\$30.00

7<sup>th</sup> Place...\$20.00

*Ties decided by time measured.*

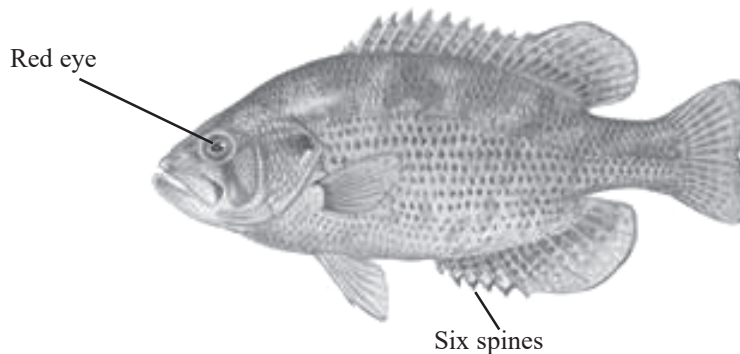



**PROANE**  
989 595-2913

*Delivering What We Promise!*

**Propane and Fuels for Residential, Commercial, Cabins & Recreation**

989-354-5524  
  
**Fueling Station**

  
**989-340-6400**

- Gasoline 
- Rec Fuel
- Diesel
- Off-Road Diesel 
- Propane Filling Station

- Propane Accessories
- Snacks
- Beverages
- Beer, Wine & Spirits
- Broaster Chicken



**FAMILY-OWNED & OPERATED**  
 1141 U.S.-23 N., Alpena, MI 49707

*Sponsor of the Special Kids Category Kids 12 and Under  
 Prizes for the Largest 5 in each category: Bluegill, Perch, Bass, Rock Bass  
 Ties decided by time measured.*

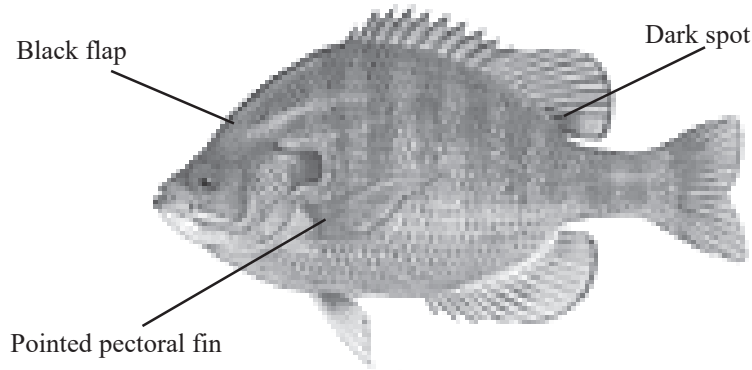

# GRAND LAKE MARINA

grandlakemarina@yahoo.com • 989-595-3365

Year Round Sales

Hewitt & Roll-A-Dock & Boat Lifts

*Serving our Area for 26 Years*

**Roll-A-Dock™ The Most  
Durable Design in  
the Industry**

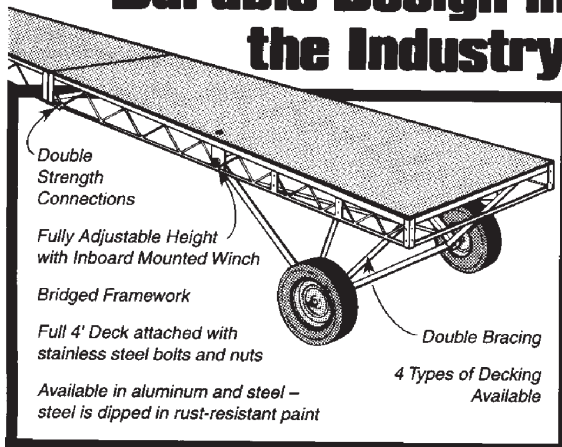

**Give Your Boat  
a Lift**

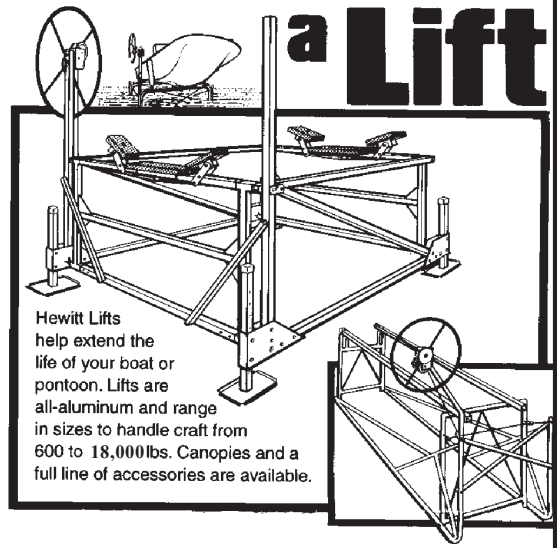





**MEDS CAFE**

[www.medscafe.com](http://www.medscafe.com)

2352 US-23, Rogers City

Adult Use & Medical

# GOOD LUCK!



## Stop in for a Test Drive!



Gene Skiba



Jimmy Skiba



Bob Centala



Cory Davis



Shaun Losinski



US23 NORTH (133 JOHNSON ST.)  
ALPENA 989.356.9011  
[www.alpenabuick.com](http://www.alpenabuick.com)



*Keep it  
reel*



**Fish Fry Every Friday**

**Happy Hour 3-5PM**

**Tuesday-Friday**

**Call for Take Out**

**(989) 358-9592**



**9101 S. Bolton Rd**



**boltonridgebarandgrill**

# PRELL'S SAWMILL

Custom Sawing,  
Planing & Kiln Drying  
Retail Sales of Vee Match  
Lumber & Log Siding  
Peeled and Hewned Posts

**Joe & Linda Kuznicki**

989-734-2939 – phone  
989-734-4664 – fax

jpsawmill@gmail.com

P.O. Box 121  
8571 County Rd. 451  
Hawks, MI 49743

192 E Huron Ave.

989-474-9199

*International*  
SPORTS BAR

Best Sports Bar in Town

Big screen TV's  
Don't Miss Your Favorite  
Games

New Owner-New Look



ROGERS CITY, MICH.

Daily food & drink  
specials

Open 7 days a week

Follow Us on Facebook

*Nourishing the Spirit of  
Grand Lake*

Rededicated to providing  
simply good goods,  
extraordinary service, and  
the neighborly atmosphere  
that lies at the heart of our  
deeply special community.



8121 E Grand Lake Rd, Presque Isle, MI 49777

@birchhillgrocery / www.birchhillgrocery.com

Bring this coupon when you next  
come enjoy the store and take

**10% off**

your entire purchase of groceries,  
dry goods, booze, and café and  
bakery items. (Gas not included.)

**Open Spring to Christmas.**

**Summer Hours: 9am - 9pm**

**NEW TEL: (989) 595-0595**





# PACKAGE SALES AVAILABLE

WE OFFER QUALITY PRODUCTS FROM THE TOP MANUFACTURERS

- Building Materials
- Windows
- Doors
- Mouldings
- EWP
- Lumber
- Decking
- Millwork
- Sheathing
- Roofing
- Siding
- Insulation

# CUSTOM SIZES & SPECS

- Pole Barn, Garage, Shed, and Deck Packages
- Accurate Material Lists
- Jobsite Delivery

[BLDR.COM/MICHIGAN](http://BLDR.COM/MICHIGAN)



**BFS ALPENA**

1441 M-32 #6 • Alpena, MI 49707 • 989.356.2106



GrekasRC

326 S. 1st Street Rogers City

(989) 734-9029



Best Bar on 1st Street

Follow Us on Facebook  
to keep up with Live  
Music, Parties & more

New Owners-Newly Remodeled



173 Pinkerton Ave, Hawks MI

(989) 734-7077

*Night Hawk*  
**BAR & GRILL**  
*Hawks, Michigan*

Located in beautiful  
downtown Hawks

Best Bar in town

Worth the drive out to  
see us

New Owners-Keno-ATM-Horseshoes-Newly Remodeled



"Our main goal is to  
make UpNorth 23 a  
destination place for  
Northern Michigan...to  
put Rogers City back on  
the map."

"We look forward to  
creating an atmosphere  
where family, friends,  
and strangers can come  
together and enjoy  
delicious food with a  
gorgeous view of our  
beloved Lake Huron."

Outdoor Dining Available Memorial  
Day to Labor Day



UpNorth23

530 N 3rd St, Rogers City

(989) 734-2323

## CLEARVIEW CAR WASH

Automatic Soft Cloth Wash

Cars • Trucks • Van

Mon. thru Sat. 8 to 6; Sun. 9 to 4  
Self-serve Bays Open 24 hours  
105 Mason • Alpena • (989) 356-1923



**PLUMBING • HEATING • COOLING**

(989) 734-2932

202 S. Third St., Rogers City, MI 49779

zgorskic@gmail.com

# DERBY'S



TACKLE & SUPPLIES

**Onaway  
Custom Embroidery  
& Vinyl Graphics**

20689 State St.,  
Onaway, MI

**Phone  
(989) 733-8538**

**Fax  
(989) 733-5060**

**HATS  
SHIRTS  
JACKETS  
SIGNS  
MAGNETS  
BANNERS  
VEHICLE  
& WINDOW  
LETTERING**

*...and more*



3137 US-23 South,  
Alpena, MI 49707

**(989) 356-4141**

**(800) 968-1976**



## STEVE'S REPAIR SHOP

Motorcycles • Snowmobiles • ATV

Steve Mischloney  
(989) 356-9222

1208 US-23 N,  
Alpena, MI 49707

Cut out & present ad for one free donut  
or cookie with purchase of any item

**Tradewinds  
Bakery**

**Donuts, cookies, cupcakes,  
custom cake orders & more!**

**213 W. Erie Street  
Rogers City MI  
989-734-4774**

*Expires 8/1/2023*

**BARRY J. SCHATZ**

Licensed Insurance Agent



**The Auto Club Group**

2534 US-23 South, Alpena, MI 49707

(989) 354-2151 ext. 176 office

(989) 358-4124 direct

(989) 358-4129 fax

bjschatz@acg.aaa.com

michigan.aaa.com/barry.schatz

*Insurance*



**THUNDER BAY  
ELECTRIC, INC**

Phone: (989) 354-2840

1693 M-32 West

Fax: (989) 356-1509

P.O. Box 472

www.thunderbayelectric.com

Alpena, MI 49707



**John Werth, Plant Manager**

1009 Long Lake Ave., Alpena, MI 49707

Office (989) 354-3502 • Fax (989) 358-9879

Cell (989) 306-1016

jwerth@spcstnprd.net • www.edwclavy.com

**Parker House**

On Long Lake

Restaurant, Cabins & Cottages

**Restaurant Open All Year**

Summer hours:

Daily 8 a.m. – 2 p.m.

Winter hours:

Friday, Saturday &  
Sunday 8 a.m. – 2 p.m.

24732 US-23 South, Wayne & Karen McWilliams  
Presque Isle, MI 49777 (989) 595-6484

**PLATH'S MEATS, INC.**  
**Smoked Meats**

LOINS • HAMS • BACON • SAUSAGE

Smoked Fish Salmon Custom Smoked

Will Smoke or Fast Freeze Your Catch



*"Custom Smoked Meat  
Specialist Since 1913"*

**(989) 734-2232**

**BENNY'S TIRE & OIL**

• Licensed Brake Service •

**OUR SERVICE STILL INCLUDE:**

Oil Changes • Mufflers • Tailpipes • Tire Sales & Service

1952 US-23 South • Rogers City • (989) 734-3547



**Boat House**

**MARINE & STORAGE**

**Alpena, MI 989-340-1120**

Indoor/Outdoor Storage

Boats/Accessories/Docks/Hoists

Yamaha/Mercury Outboards

Full Service & Repairs

2015 Hamilton Rd.





**PROUDLY SERVING YOU SINCE 1900**  
**BOB, NAAKO, MARY, BEN, JASON & KATIE YOUNG**  
**AND OUR AMAZING TEAM!**

Keep it local with us  
**WWW.YOUNGAPPLIANCE.COM**



Call us today! (800) 237-8778  
 2509 US-23 South, Alpena •



**2023 Presque Isle Area Calendar**

<b>Date/Time</b>	<b>Activity</b>	<b>Location</b>	<b>Sponsor</b>
May 27 (8-10:30)	Pancake Breakfast	Presque Isle Lodge	G.L. Association
June 3& 4 (10-5)	Fireside 500 Boat Races	Fireside Inn	
June 10 & 11	Free Fishing Weekend		
June 17 (10-4)	Wooden Boat Show	Presque Isle Harbor	
July 1 (10-1)	July 4th Picnic & Parade	New Lighthouse Park	
July 1 dusk	Fireworks	Presque Isle Harbor	
July 8	47th annual Fishing Derby	Grand Lake	G.L. Sportsman
July 8 (6-7:30)	Ice Cream Social	Homestead Park	
July 15 (10-1)	Cornhole Tournament	Homestead Park	G.L. Association
July 28 & 29	Annual Garage Sale Days	around the lake	G.L. Association
Aug. 3-6	Nautical City Festival	Rogers City	
Aug. 12 (10-4)	Arts & Crafts Show	Homestead Park	
Sept. 2 (4-6)	Labor Picnic	New Lighthouse Park	
Sept. 9-10	Posen Potato Festival	Posen	

**North Coney Island**

2668 US-23 South  
**989-354-2315**

Open 7 a.m. to 4 p.m.  
 Weekdays  
 Breakfast Every Day  
 8 a.m. to 4 p.m. Saturdays  
 8 a.m. to 1:30 p.m.  
 Sunday (breakfast only)



**PRESQUE ISLE  
 HARBOR  
 ASSOCIATION  
 INC**

P.O. Box 60  
 Presque Isle, MI 49777  
 (989) 595-2411  
 Fax: (989) 595-3183

**Jacob Kroll**  
 Executive Director

[presqueisleharbor.org](http://presqueisleharbor.org)

*Budweiser* **BUD LIGHT**

*Huron Dist.*  
*Ina*

**BUSCH** ALPENA / INDIAN RIVER **BUSCH**  
BEER LIGHT

(989) 354-3450  
Fax (989) 354-4475

- Custom Crankbaits
- Planer Boards
- Trolling Accessories



**GATOR BAIT TACKLE**





Gatorbaittackle.com

“The Official Bait of Grand Lake”

 **MillerCoors™**

**Alpena Beverage**

(989) 354-4329  
alpbev@alpenabeverage.com

- |   |                          |   |                          |
|---|--------------------------|---|--------------------------|
|  | Installed Winter of 1985 |  | Installed Winter of 1992 |
|  | Installed Winter of 1986 |  | Installed Winter of 1993 |
|  | Installed Winter of 1987 |  | Installed Winter of 1994 |
|  | Installed Winter of 1988 |  | Installed Winter of 1995 |
|  | Installed Winter of 1989 |  | Installed Winter of 1996 |
|  | Installed Winter of 1990 |  | Installed Winter of 1997 |
|  | Installed Winter of 1991 |   |                          |

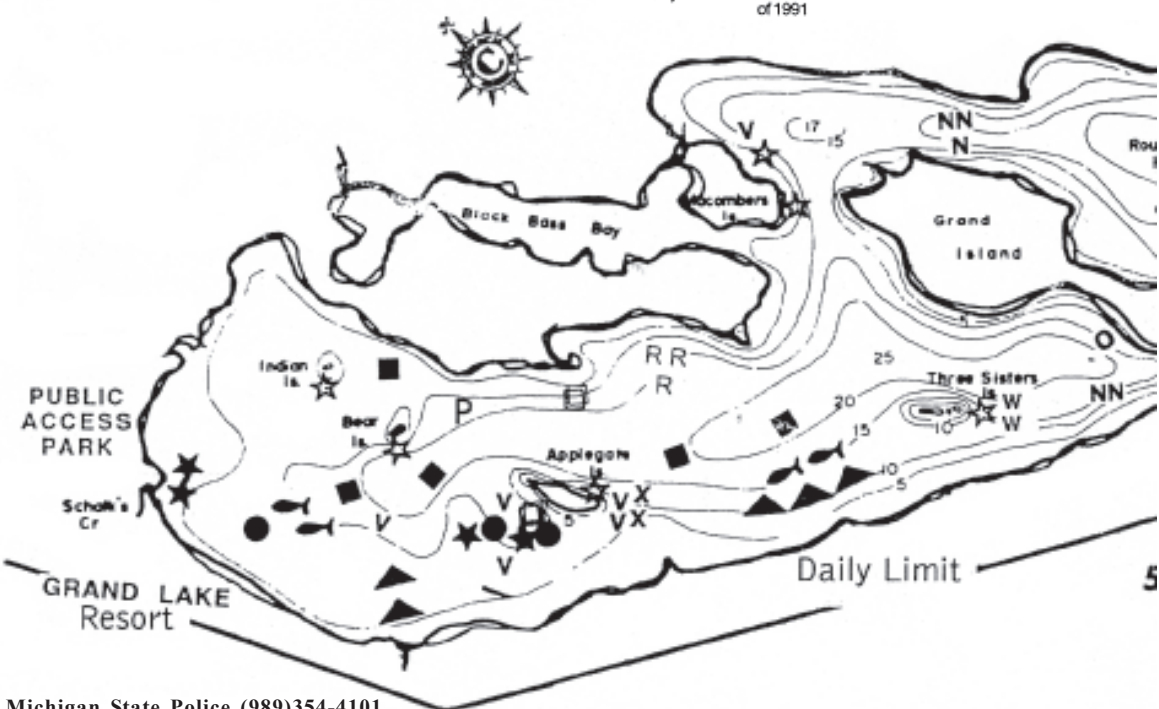

Michigan State Police (989)354-4101  
Sheriff, Presque Isle County  
(989)734-2156



Owner/Operator Michele Gallagher

## Grand Lake Resort

15103 US-23 South,  
Presque Isle, MI 49777  
Phone: (989) 595-6090

E-mail: grandlakeresort@yahoo.com

# SAND BAY TRADING CO.



# WOODY'S GRAND LAKE

Presque Isle's year 'round  
Restaurant &  
Convenience Store  
**989-595-0242**

**H** Installed Winter of 2000  
**U** Installed Winter of 2002  
**N** Installed Winter of 2003  
**T** Installed Winter of 2005  
**E** Installed Winter of 2006  
**R** Installed Winter of 2007

**S** Installed Winter of 2008  
**P** Installed Summer of 2011

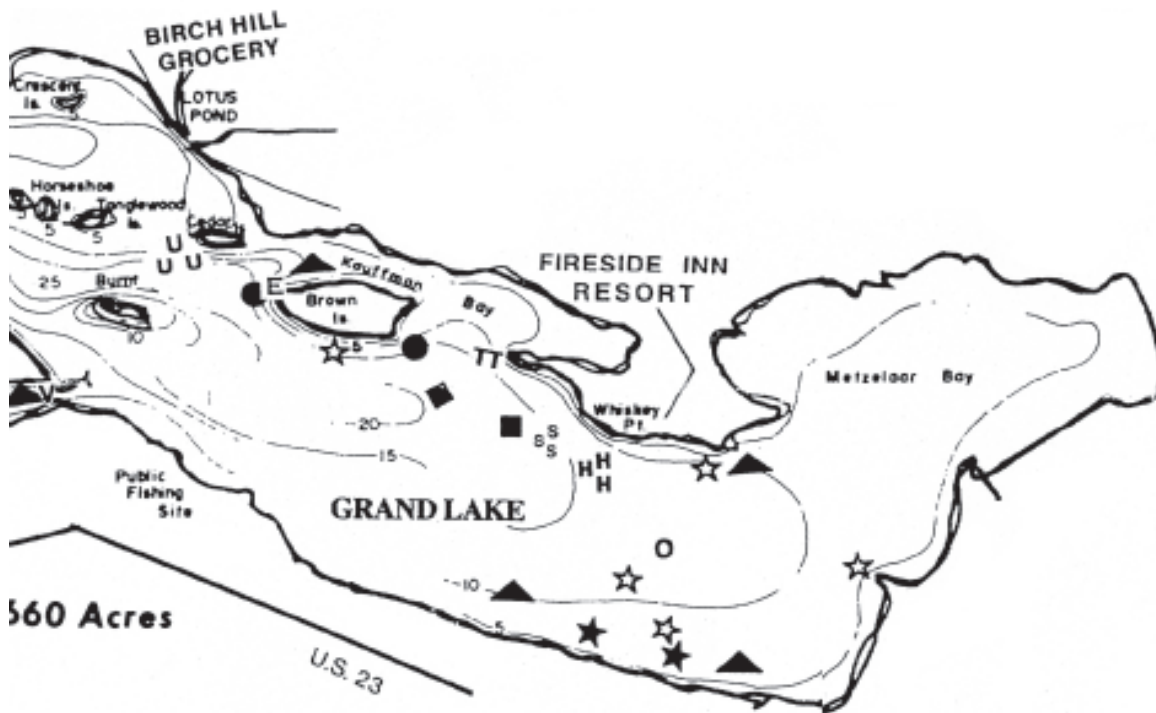

**GRAND LAKE SPORTSMEN'S CLUB**  
**WINTER FISH DERBY February 11, 2023**  
**WINNING FISH**

**PERCH**

Jeremy Scheske	14"
Earl Dault	13 3/4"
Gaven Achatz	13 3/4"
Athen Kent	13 3/4"
Ryan Wiczorkowski	13 1/2"
Dean Schmanski	13 1/2"
Myah Zybel	13 1/2"
Kris Eades	13 1/2"
Don Urban	13 1/2"
Zack Schaedig	13 1/2"
Ryan Katchuba	13 1/4"
Paul DeYoung	13 1/4"
Kaden Morre Thomas	13 1/4"
Jeff Krug	13 1/4"
Nolan Krentz	13 1/8"

**PIKE**

Dick Morrison	29 1/2"
Kris Soldenski	28"
Matt Lash	26 1/2"
Alex Jozwiak	26 3/8"
Gaven Achatz	24"

**WALLEYE**

Matthew Mischley	26 1/2"
John Kortman	22 1/4"
Connor Mischley	20 5/8"
Wyatt Gamps	20 1/2"
Kris Eades	20 1/2"

Ties go by Time Fish was registered

**GRAND LAKE SPORTSMEN'S CLUB**  
**Annual Fish Derby At Grand Lake July 9, 2022**

**WINNERS**

**WALLEYE**

Wayne Romel	20"
Brenda Huesner	20"
Connor Cameron	19 3/4"
Simon Duthler	19 3/4"
Oliver Duthler	19"
Walter Weinkauff	18 7/8"
Dennis Harris	18 3/4"

Jay Palmer	10 1/2"
Ken Douglas	10 1/2"
Scott Reisner	10 1/2"
Dave Santi	10 1/2"
Francesco Ruggirello	10 3/8"

Connor Bedford	9 3/4"
Vincenzo Ruggirello	9 3/4"
Henry Szydowski	9 5/8"
Parker Bedford	9 1/2"
Dylan Tobias	9 3/8"
Isla Weinkauff	9 1/4"
Bentley Hall	9 1/8"
Olivia Meyer	9 1/8"
Case Huston	9"
Charlotte Bedford	9"
Arrianna	9"

**ROCK BASS**

Jeff Furmanczyk	11"
Scott Reisner	6 1/2"
Shane Reisner	6 1/4"
Steve Reisner	6 1/8"

**ROCK BASS**

Greyson Srebnik	11 1/8"
Evan Reisner	9 1/8"
Connor Bedford	8 3/4"
Parker Bedford	8 1/2"
Emily Weinkauff	7"

**BASS**

Jeff Griffiths	18 3/4"
Ashley Kelly	18 3/8"
Aaron Buza	17 7/8"
Dakota Owen	16 5/8"
Toby Niedzwiecki	16 1/2"
Connor McMurray	15 1/8"
Brett Kortman	15"

**PIKE**

Rick Przytulski	28 1/2"
Boone Skiba	27"
Chris Stockly	24 5/8"

**KIDS 12 & UNDER**

**PERCH**

Alex Ventimiglia	11 3/4"
Mike Beeson	11 1/8"

Ameila Evosirph	11"
Zack Robarge	9 7/8"

**BLUEGILL**

McKendra Lanning	7 7/8"
------------------	--------

Come See Us for Your Next Mortgage Loan!



**Alpena  
Alcona Area  
Credit Union**



(989) 354-1515



We offer a variety of mortgage options and home equity loans.

PHONE: (989) 595-2265

*Shannon's*

**"HEAD" QUARTERS**  
*Men's & Women's Styling*

18195 Brooks Hwy.,  
Alpena, MI 49707

SHANNON ANDRZEJEWSKI

Brian Pagels

Tom McMillan



**LAKESHORE**

PLUMBING, HEATING & COOLING, INC.

1587 M-32

West, Alpena, MI

Phone: (989) 354-7574

Fax: (989) 358-1077

Fully Licensed & Insured

**K & K Electric**  
With Prices That Won't Shock You

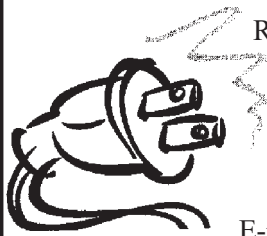

Plug into the Pros

Rich Kadow, Owner  
Licensed & Insured  
Residential & Commercial  
6784 East Metz Hwy.,  
Posen, MI 49776  
Office: (989) 766-8873  
Fax: (989) 766-2222  
E-mail: kkelectric@i2k.com



**GARAGE DOOR/OPENERS**

**SALES/SERVICE/INSTALLATION**

PROFESSIONALLY INSTALLED  
GARAGE/ENTRY/STORM DOORS  
REPLACEMENT WINDOWS  
AWNING - ALUMINUM/FABRIC  
DIY PARTS AND ADVICE

2250 US-23 S, Alpena

(989) 354-8316

**Tulgestka Transport  
Inc.**



800-346-8074 ext. 333 989-619-1234 Cell  
Jeremy Tulgestka 989-734-3526 Fax

jeremy@tulgestkatrans.com

**STANDARD**  
ELECTRIC COMPANY

**Steve Partyka**  
Branch Manager

1055 Crittenden Court  
Alpena, MI 49707  
www.standardelectricco.com

Office (989) 356-4521  
Toll Free (800) 322-3029  
Fax (989) 354-4986  
Cell (989) 916-7309

steve.partyko@standardelectricco.com



Iron and Metal Company  
 Escanaba • Gaylord • Ishpeming • Kincheloe • Alpena Divisions

Glen Gambrel,  
 Manager

Phone: (989) 354-6780  
 alpena@alironandmetal.com



**SAND BAY  
 MARINA**

SALES SERVICE STORAGE

Kevin Krajniak • Brandie Krajniak

**989-595-2502**

14019 US Hwy 23 South, Presque Isle, MI 49777

**MCDONALD  
 BROS  
 COLLISION**

Est. 1960

**(989) 354-8493**

Alpena, MI



Between Long Lake and Grand Lake

Phone: (989) 595-6787

10085 US-23 North,  
 Alpena

Offering Full Menu  
 Serving Dinner at 4 p.m.  
 Closed Mondays  
 Dine In or Take Out

Automotive  
 Machine Shop Services

**McDonald Auto Supply**

126 W. Washington,  
 Alpena, MI 49707



Phone: (989) 356-4544



**LeAnn Burns, O.D.**

*Up North Eye Care*

224 E Chisholm St., Ste A  
 Alpena, MI 49707  
**(989) 354-5890**

100 W. Erie  
 Rogers City, MI 49779  
**(989) 734-3456**

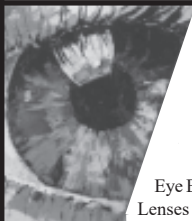

Eye Exams, Frames &  
 Lenses & Contact Lenses

**FLYING DUCK**



989-766-2212

5029 E 634

**Food & Spirits**

**Posen, MI**

Phone: (989) 354-4366 COLD BEER & WINE

# Jimmie Garant's

**PARTY STORE**  
Alpena, MI

• PACKAGE LIQUOR •  
**Large Display of Craft Beer**

WEDDINGS & PARTIES OUR SPECIALTY  
1226 W. Chisholm, ALPENA, MI 49707



989-356-1992

## The Downtown Union 76

COMPLETE AUTO SERVICE  
201 E. CHISHOLM ST., ALPENA, MI  
SHELDON SCHMIDT  
Certified Technician



*For The Farm, Forest & Factory*





STORMY KROMER

**carhartt**

**EMERY ENTERPRISES**

144 W. WASHINGTON AVE - DOWNTOWN ALPENA, MI



**ALPENA**  
VETERINARY & CLINIC  
*Providing traditional & alternative medicine for all*  
(989) 354-2925  
[www.alpenavet.com](http://www.alpenavet.com)



**Family Dining**  
**Soup & Salad Bar**  
**Homemade Pizza**

Open Daily 11 a.m.

BANQUET FACILITIES  
UP TO 100 PEOPLE

377 N. Third,  
Rogers City  
(989) 734-4858



BPA  
Fun  
Center



**NAUTICAL LANES**  
14 AMF Lanes • Pro Shop • Glow Bowling

**Scott, Brian & Luanne Bannasch,**  
*proprietors*

391 N. Third St., Rogers City  
(989) 734-3250



1025 US-23 North, Alpena, MI 49707  
 (989) 354-4012 • Fax: (989) 356-4300  
[www.perchsigna.com](http://www.perchsigna.com)

**WHAT PERCH'S WAS BUILT ON...  
 PUREST, FRESHEST MEAT PRODUCTS EVERYDAY!**

**INVESTMENT NAVIGATORS**

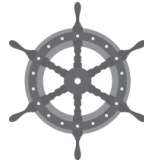

**MOLLY BENSON**  
 Financial Advisor

**(989) 356-5678**

122 W. Chisholm St.  
 Alpena, MI 49707  
[molly.benson@woodburyfinancial.net](mailto:molly.benson@woodburyfinancial.net)



**133 Chisholm St.,  
 Alpena, MI  
 Gifts & Apparel  
[cedarandthreads.net](http://cedarandthreads.net)**

**Lee's Auto Parts**

Used Auto Parts For Most Makes & Models  
 Late Model Wrecks Bought & Sold

**(989) 356-9617**

**(989) 354-2910**

Mon.-Fri. 8:30 a.m. to 5:30 p.m.  
 Sat. 8:30 a.m. to noon

5221 US-23 North, Alpena, MI 49707

**KOWALSKI AGENCY, INC.**

*Complete Insurance Service*

**Phone: (989) 734-3880**

141 South 3<sup>rd</sup> Street,  
 Rogers City, MI

**GRAND LAKE HOTEL**

Built in 1912



Ruth & Christopher Cooper  
 P.O. Box 95, 9258 Leavitt Dr.  
 Presque Isle, MI 49777  
 (772) 216-9021  
[GrandLakeHotel@aol.com](mailto:GrandLakeHotel@aol.com)  
[www.Grand-Lake-Hotel.com](http://www.Grand-Lake-Hotel.com)



**OVERFLOW GUESTS – SMALL EVENT RENTALS – ENGAGEMENT PARTIES  
 BRIDAL SHOWERS – REHEARSAL DINNERS – SMALL WEDDINGS – BABY SHOWERS  
 ANNIVERSARY PARTIES – SMALL FAMILY GATHERINGS – CORPORATE PARTY**



# DR. STEBER



&  
**STAFF Dentistry**

174 N. Ripley Blvd.,  
Alpena, MI 49707  
**(989) 356-6411**



**ALPENA  
AGENCY, INC.**

Insurance & Employee Benefits

Call (989) 354-2175  
Text (989) 354-2175  
Fax (989) 354-8974

*We Make  
Insurance  
Easy!*

Auto • Home • Life • Health • Medicare • Business  
*Anywhere in Michigan*

102 S. Third Avenue • Alpena, MI 49707

[www.alpenaagency.com](http://www.alpenaagency.com)

[insurance@alpenaagency.com](mailto:insurance@alpenaagency.com)

# RUSTY PETUNIAS MARKETPLACE



*Rusty Petunias Marketplace is a unique shopping experience. Come in and enjoy a glass of wine, beer or an occasional specialty martini while you shop.*

- Home Decor
- Specialty Gifts
- Souvenirs
- Personalized Engraving
- Bar and Lounge
- Wine, Craft Beer & Liquors
- Charcuterie Trays
- Specialty Foods
- Candy & Sweets
- Women's Accessories
- Boutique Clothing
- Kitchen Accessories



**The Source For The North  
Classic Kitchen & Bath**

*“Design Specialists”*

**(989) 354-2181**

**(800) 968-6333**

410 Eleventh Ave., Alpena



**TERRY KING**  
Sales Associate



(989) 356-6366  
Cell: (989) 464-4201  
terryking@deanarbor.com



1001 US-23N • Alpena, MI 49707

**Sunrise Side Appraisal**

**Richard A. Bannasch**  
State Certified Residential Real Estate Appraiser



Office: (989) 595-9951  
6160 Grand Point Rd., Fax: (888) 330-9951  
Presque Isle, MI 49777 E-mail: ssappraisal@yahoo.com



**McFalda Law Office, PLC**  
**DO YOU NEED A WILL? OR A TRUST?**  
**Free Initial Consultation**  
Judy McFalda, Attorney-at-Law  
(989) 734-4486 Rogers City

**Huron Veterinary Clinic**

Chelsea VanAssche, DVM



3189 US-23 South, (989) 734-3731  
Rogers City, MI 49779 Emergency Service Available



**Community  
Commitment  
since 1881**

401 N. Ninth Avenue, Alpena, MI  
989-358-4900  
866-358-4900  
www.alpenapower.com  
...low rates and exceptional reliability in northeast Michigan

**DODGE** Marine & Storage  
*On Scenic East Long Lake*



**Indoor & Outdoor Boat  
Storage & Shrink Wrap**

Boat Hoists • Bennington Pontoons  
Marine Service Dept.



Locally Owned & Operated  
(989) 595-5040

2111 Long Lake Park Road, Alpena



Pinewoodtavern

1081 Dettloff St, Rogers City

(989) 734-4152

Meet ya at the Woods

Stop in for a burger, a  
beer and some  
cornhole out back



Open 7 days a week

Follow Us on Facebook

**Voted Greatest "Living Room Bar" in the World!**

## BEUTER BUILDING AND CONTRACTING

Complete Remodeling, Maintenance  
and New Construction  
This Area's Brock Vinyl Dock Dealer

Since 1974

P.O. Box 125,

Presque Isle, MI 49777

Phone: (989) 595-6974

Fax: (989) 595-6974

## Copping Auto Service, LLC

Foreign Domestic  
Engine Repair Manual Trans &  
Axles Front End Steering  
Braking Systems Electrical System  
Heating & Air Conditioning  
Engine Tune-up Automatic Transmissions  
Tire Service and Sales

7329 US-23 N,  
Alpena, MI 49707  
(989) 595-6000



Mark A. Copping/Owner  
Master Certified Mechanic  
MI86713



5900 US-23 NORTH, ALPENA, MI 49707  
www.abchomesalpena.com

Mark & Teena Holmes

(989) 356-2621



### Carquest Auto Parts

115 Lockwood  
Alpena, MI 49707  
(989) 354-2166

Auto Parts and  
Industrial Equipment

Custom Mix Paint  
PPG Ditzler

## Northern White Cedar LLC

Cedar Fencing – Cedar Paneling –  
Cedar Siding and mulch

*Dennis Nowicki*

2510 W. LaComb Road  
Alpena, MI 49707

Phone: (989) 657-2991

Email: nowickil2441@hotmail.com





# EAGLE PRINTING SERVICE

4096 Long Rapids Rd.,  
Alpena, MI 49707  
Phone: (989) 354-8337  
eagleps@charter.net

From Business Cards to Banners  
we provide Quality Printing  
and Promotional Products  
at affordable prices.  
QuickBook Laser Checks  
Screen printing and Embroidery

**Mark A. Wieschowski,**  
**Owner/Sales**

**Over 25 years experience**

**www.eagleprintingservice.com**

## MARINE MEAT MARKET

**Homemade** 515 Ripley Blvd., **Party**  
**Smoked** Alpena, MI 49707 **Trays**  
**Meats** *Serving Alpena since 1888*  
Store: Fax:  
(989) 354-5505 (989) 356-4799

### Walleye

dark blotch and fins not connected

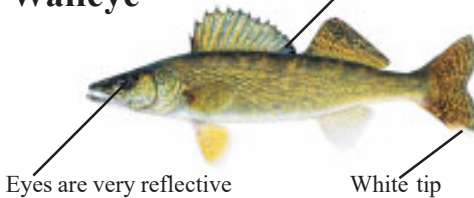

Eyes are very reflective

White tip

web: omegaelectricandesign.com

## Full Service Sign & Electric Company

Serving all of Michigan  
New Sign Design & Installation- Sign Repair  
Refurbished Signs - Lighted & Non-Lighted



- LED Message Centers –
- Channel Letters
- Wall Signs – Pylon –
- Parking Lot Signs
- Awnings – Vehicle Graphics –
- Flag Poles - Banners –
- Custom T-Shirts – Stickers
- Decals – Magnets – Yard Signs
- Electrical Contracting & Service
- Commercial – Industrial –
- Residential

## T.N.T. BAR

Stop and Get  
Bombed



County Road 451  
(989) 734-4300

Owner  
Gus Neumann



1074 US-23 N., Alpena, MI **ALPENA, MI** (989) 354-3157

**Toll free: (800) 996-6604**

Service & Bod Shop hours:  
Monday – Friday 7:30 a.m. – 5:30 p.m.  
Keep That Great GM Felling with Genuine GM Parts  
Check US Out on the Web: www.cliffanschuetz.com



Mr. Goodwrench

Mr. Goodwrench



Alpena, MI  
 304 N. 9<sup>th</sup> Ave., Alpena • 354-2070  
 on the Thunder Bay River  
**HUNTING & FISHING LICENSES**

# Kipfmiller's

**Produce & Meats, Inc.**  
 2584 US-23 South, Alpena  
**(989) 356-2412**



Deli Meat & Cheese,  
 Plants & Flowers,  
 Fresh Fruits & Vegetables,  
 Fresh & Smoked Meats,  
 "Get it Fresh"

# meijer®

## Fitzpatrick's Hardware

2733 US-23 South, Alpena, MI 49707  
 fitzpatrickshardware@gmail.com  
**(989) 340-2132**

**RENTAL - LUMBER - HARDWARE**  
**Milwaukee Tools**  
**Outdoor Power Equipment**

5472 E. Grand Lake Rd.  
 Presque Isle

**989-595-5095**



## PORTAGE STORE AND DELI

Groceries • Deli • Beer • Wine • Pizza • Packaged Liquor  
 • Hunting /Fishing License/Bait

• Hudsonville Hand Dipped Ice Cream Cones  
 • Gift Shop • Featuring the Largest Selection Of  
 Presque Isle, Lake Huron Apparel & Souvenirs

Across from Presque Isle Harbor  
 Open 7 days a week (May - Mid-October)



# Jack's Barbershop

*Open  
Tuesday-Saturday*  
404 N. 3rd Street  
Rogers City



10760 Michigan Ave, Posen, MI 49776  
**989-766-8365**  
Join us on Facebook for  
hours and weekly specials

## X-TREME TIMBER CUTTING LLC

Art Nowicki  
989-255-4437



**Specializing in Harvesting  
Standing Timber ~ Insured**



2673 US-23 South  
Alpena, MI 49707

**R.J. Bordeau**  
Owner

Phone: 989-354-8983  
Fax: 989-354-3560  
e-mail: z-mi10@ziebart.com

## HOLY SMOKES TOBACCO & CIGAR SHOPPE

**#1 Smoke Shoppe of the North!!**

148 S. Ripley St., Alpena, MI  
718 1/2 US-23, East Tawas, MI

989-3403342 Alpena, MI  
989-305-6851 East Tawas, MI  
Holysmokes48730@hotmail.com





# Lakeshore Realty

Your specialists for Waterfront and Forest Property in Presque Isle

**HOMES • LOTS • ACREAGE**

7750 E. Grand Lake Rd., Presque Isle • **Phone: (989) 595-2970**

Find Us On  
Facebook

On the web: [www.lake-shore-realty.com](http://www.lake-shore-realty.com)



## LEGACY BUILDERS

designed by KENDZIORSKI, INC.

### SPENCE KENDZIORSKI

Phone: 989-255-7998

Email: [kendziorskiinc@gmail.com](mailto:kendziorskiinc@gmail.com)

### Posen Auto Parts LLC

10941 Michigan Ave.,

Posen, MI 49776

**Phone: (989) 766-2495**

**(989) 766-9917**

“Your Local Auto Value Parts Store”

Domestic & Import Auto Parts, Marine Parts  
Lawnmower Parts, High Performance Parts  
Dupont + Mason Auto Paint, Quad Parts, Oils  
Chemicals, Oregon Bars, Chains & Sharpening  
Tractor Parts & Drum Oils

### WAYNE’S

### SHARP-ALL SERVICE

Power Equipment, Sales & Service  
Tool Sharpening

2246 US Hwy. 23 South,  
Rogers City, MI 49779

**(989) 734-4053**



## WMCR Co.

1130 State Ave.,

Alpena, MI 49707-2419

(989) 356-4311

Franchisee of KFC Corporation

## It's Always Summer at the Sandbar

On Long Lake  
Alpena, MI

**Best Ribs  
in Town!**

## & Grill

- Nightly Food Specials
- Thursday & Sturday BBQ Ribs
- Friday – Fish Fry
- Open for Lunch Daily

**Pizza Burgers Hoagies  
Bloomin' Onions and Much More!**



**Live Entertainment Every Saturday**

9027 W. Long Lake Rd., Alpena • (989) 595-0009

Hours: Sun. – Thurs., 12-10 p.m., Fri. & Sat. 12 p.m.- 1 a.m.

**Bigger Salt Water Fish Asst.**

**Dedicated Fish Room**

*Kama's a Fish!*

**Live Feeder Insects**

**Frozen Mice & Rats**

ALPENA, MI



**James L. Vedder, D.D.S., M.S.**  
*Specialist in Orthodontics*

176 N. Ripley Blvd.,  
Alpena, MI 49707



(989) 356-3655  
Fax: (989) 356-2204



## RYGWELSKI'S IGA

Phone/Fax (989) 734-3248

Toll free 1-866-4KABASA (1-866-452-2272)

495 S. First Street

Rogers City, MI 49779

**Rygwelski's  
MainStreet Deli**

**186 S. Third  
474-9265**



## Culligan Water

**CHRIS PAPKE**

Water Treatment Expert

cell: (906) 630-4519

chris@dmwaterworks.net

CulliganRogersCity.com

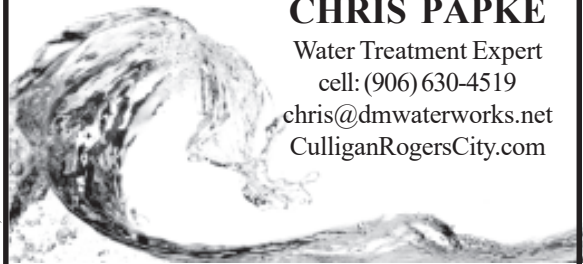

**Rogers City: (989) 734-2959  
Sault Ste Marie: (906) 632-6200**





**YELLOW PERCH** 6 to 8 dark bands

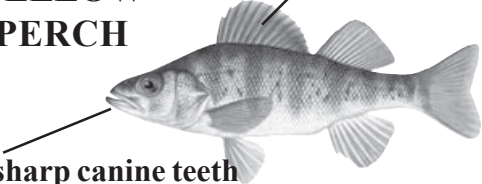

No sharp canine teeth

**Green Acres**  
 Food Plot Seeds  
**Feed and Seed**  
 2316 M-32 • Alpena, MI  
**(989) 884-1365**  
 Locally grown & harvested!



**Grand Lake Tree Service**  
 Insured & Very Affordable

Timothy Wieczorkowski, Owner  
 6616 Black Bass Bay Rd., Presque Isle, MI 49777

Pruning, Trimming, Cutting  
 Stump Grinding & Clean-up

**No Job Too Small**  
**(989) 595-3198**



**A & J Pools & Spas**  
 Authorized Hot Springs Portable Spas Sales & Service Professional

2078 M-32 W., Alpena, MI 49707  
 Al Skiba Jr., Owner  
 albertskiba@hotmail.com  
 Phone (989) 354-3632  
 Fax: (989) 356-4981



*Beck Funeral Home*  
 Ted Beck, Owner/Manager

229 North First Street,  
 Rogers City, MI 49779

**(989) 734-2288**



**ROMEL SERVICES**  
 CUSTOM BUTCHER &  
 SAUSAGE SHOP

CUSTOM SLAUGHTERING & CUTTING  
**CATTLE PIGS SHEEP GOATS**  
 MEAT IS VACUUM PACKED  
 SMOKED MEAT  
 SERVICES AVAILABLE

**7482 HINCKA RD. POSEN, MI 49776**  
**989-766-8129**



**Wolverine State Credit Union**

Proud Sponsor of the Community

1381 N. Bagley & 417 W. Chisholm, Alpena, MI  
**(989) 356-1880 & (989) 354-2850**

## Losinski Excavating & Septic Tank, Inc.

Specializing in Tanks & Fields



Irrigation  
Sand and Gravel  
Bulldozing

Owned by Perry Losinski

5281 US-23 North  
Alpena, MI 49707

Phone: (989) 356-1151  
Fax: (989) 358-8503

## HINCKA LOGGING LLC



*Posen, MI*

766-8893

Firewood For Sale  
Buying Standing Timber



Where today's treasures become  
tomorrow's heirlooms!

Wayne Calkins • Susan Calkins  
[www.bolenzjewelry.com](http://www.bolenzjewelry.com)

(989) 354-4860

131 W. Chisholm,  
Alpena, MI 49707

10944 E. Grand Lake Rd.

Presque Isle, MI 49777

Phone: (989) 595-2861

Joseph Stieber

## JES TAX SERVICE

Individual, Corporate, Partnership Tax Returns



10812 Michigan Ave.,  
P.O. Box 157,  
Posen, MI 49776  
(989) 766-2282



100 Years of Northern Michigan's Finest  
Sausage making with locations in Rogers City,  
Alpena & Gaylord Order online to have  
shipped to your door at  
[www.NowickisSausage.com](http://www.NowickisSausage.com)

## FIRESIDE INN

*Since 1908*



Breakfast: 8:30 to 10:30 a.m. Weekends & Holidays  
9 to 10 a.m. Weekdays

Dinner by Reservation 5 to 6:30 p.m.

**Call (989) 595-6369**

Cabins and Rooms

**18730 Fireside Hwy., on East Grand Lake**



**989-657-4325**

[www.twoheartedcharters.com](http://www.twoheartedcharters.com)

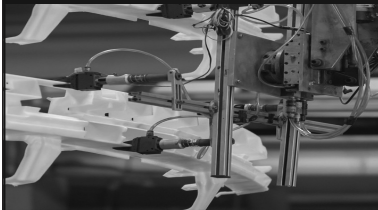

**As a fourth-generation, family-owned and managed business, Cadillac Products Automotive Company is dedicated to continually providing innovative and forward-thinking solutions.**



**CADILLAC PRODUCTS  
AUTOMOTIVE COMPANY**

**DEDICATED TO THE NEXT GENERATION!**

*...of EMPLOYEES...of CUSTOMERS...  
of SUPPLY PARTNERS...of SHAREHOLDERS*

4858 Williams Road • Rogers City, MI 49779  
Phone: (989) 340-6800

[www.cadprodauto.com](http://www.cadprodauto.com)



**Steve Spencer,  
Innkeeper**

E-mail: [pilodge@hotmail.com](mailto:pilodge@hotmail.com)  
[www.presqueislelodge.com](http://www.presqueislelodge.com)

**(989) 595-6970 Summer • (231) 357-9548 Cell**

**8211 E. Grand Lake Rd., P.O. Box 84, Presque Isle, MI 49777**